

REASONING ABILITY

1. CODING - DECODING
2. ALPHABETICAL OPERATIONS
3. NUMERICAL OPERATIONS
4. BLOOD RELATIONS
5. SYLLOGISM
6. SEATING ARRANGEMENT
7. DATA SUFFICIENCY
8. ANALYTICAL ABILITY
9. DIRECTION SENSE ABILITY
10. RANKING
11. ANALOGY
12. CLASSIFICATION
13. SERIES
14. LETTERS, NUMBERS & SYMBOLS ARRANGEMENTS
15. MATHEMATICAL SYMBOL OPERATION
16. STATEMENT AND CONCLUSIONS
17. DECISION MAKING

1. CODING – DECODING

It is a test forming part of the Aptitude or Psychological tests in various examinations. In this type of test, words or numbers which do not show their own real values are given. For example "Lion" is coded as "Goat", while Lion can never be compared to goat in real value. Thus, it is only imaginary value. Such imaginary values are called coded values or coding. This imaginary coding is based on certain principle or rule. In the same way, imaginary value or coding will be given to convert it to the real value. This method is called 'Decoding'.

The general method followed in this type of test is generally, following a reverse order, or skipping of letters between the given letters of the real and code and so on.

Candidates are required to find out the rule followed in such coding and decoding tests. Few examples are given below :

Example 1 :

If "REVIEW" can be written as TGXKGY, how will VISION be written?

Compare the letters of the real word with coded word. For instance, between R and T, S is left out and T is assigned as the code for R. The same pattern is followed in sequence. In the same way VISION can be written as XKUKQP.

Example 2 :

If DENTAL is written as WVMGZO, how WORLD can be written?

As said above compare individual letters. D is assigned W, both are fourth letters from normal and reverse order of the alphabets respectively. The same logic is applied for all the letters of DENTAL. In the same way "WORLD" can be written as DLIOW.

Example 3 :

If 'House' is coded as 'Ball', 'Ball' is coded as 'Pen', 'Pen' is coded as 'Pencil' and 'Pencil' is coded as 'Book', then with what would you play?

Answer is PEN because ball is coded as Pen.

REVERSE ORDER

A	Z
B	Y
C	X
D	W
E	V
F	U
G	T
H	S
I	R
J	Q
K	P
L	O
M	N



Direction (Qns. 1–3) : Study the following information carefully and answer the questions given below :

In a certain code language 'led so ta na' is written as 'India is rich country', 'ta pa na phi' is written as 'people country call rich' and 'pa ta rob zi' is written as 'call him rich man'.

1. What is the code for 'India'?

- A) so B) led
C) ta D) Either so or led
E) na

2. How is 'people' written in that code language?

- A) ta
B) phi
C) na
D) Can't be determined
E) None of these

3. What would be 'pa phi rob zi' called in that code language?

- A) call him is India
B) call people rich him
C) call people man him
D) call people India him
E) None of these

Sura's ♦ Reasoning Ability

Explanation (1–3) :

led so ta na → India is rich country
 (i)
 ta pa na phi → people country call rich
(ii)
 pa ta rob zi → call him rich man
(iii)
 From (i), (ii) and (iii), we have
 ta → rich (iv)
 From (ii) and (iii),
 pa → call (v)
 From (i) and (ii)
 na → country(vi)

rich	call	country	people	India	is	him	man
ta	pa	na	phi	led or so	led or so	rob or zi	rob or zi

1. D) 2. B) 3. C)

4. In a certain code PAGE is written as '3%7@', SORE is written as '8©9@'. How is 'PEAS' written in that code?

- A) 3@©8 B) 3@%9
 C) 3@%8 D) 3%©8
 E) None of these

Explanation : **Ans : C**

P	A	G	E	S	O	R	E
↓	↓	↓	↓	↓	↓	↓	↓
3	%	7	@	8	©	9	@

Therefore,

P	E	A	S
↓	↓	↓	↓
3	@	%	8

5. In a certain code 'MOUSE' is written as PRUQC. How is 'SHIFT' written in that code?

- A) VKIRD B) VKIDR
 C) VJIDR D) VIKRD
 E) None of these

Explanation : **Ans : B**

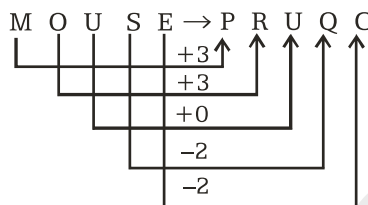

Similarly,

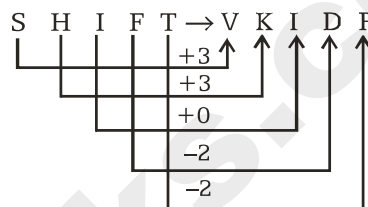

6. In a certain code FINE is written HGPC. How is SLIT written in that code?

- A) UTGR B) UTKR
 C) TUGR D) RUGT
 E) UJKR

Explanation : **Ans : E**

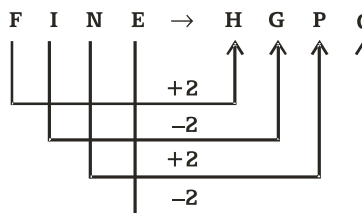

Similarly,

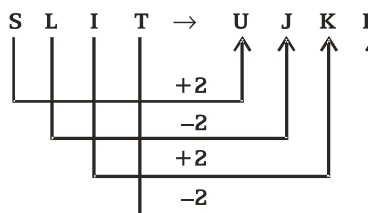

7. In a certain code BOARD is written as 54#12 and MORE is written as 941\$. How is DREAM written in that code?

- A) 21\$#9 B) 2\$1#9
 C) 51\$#9 D) 25\$#9
 E) None of these

Sura's ♦ Reasoning Ability

Explanation :

Ans : A

B O A R D M O R E
 ↓ ↓ ↓ ↓ ↓ ; ↓ ↓ ↓ ↓
 5 4 # 1 2 9 4 1 \$

Therefore,

D R E A M
 ↓ ↓ ↓ ↓ ↓
 2 1 \$ # 9

8. In a certain code language 'SPRAY' is coded as 'RQQBX' and 'LIONS' is coded as 'KJNOR'. In the same code language, how will 'TANKS' be coded as

- A) RCLMQ B) RBMKQ
 C) SBMKT D) RCLKS
 E) SBMLR

Explanation :

Ans : E

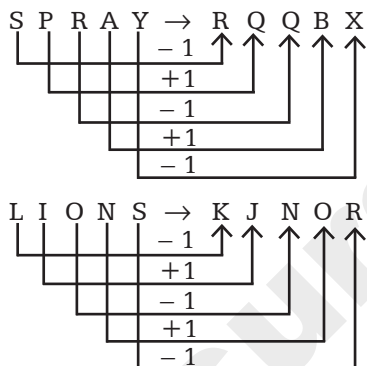

Similarly,

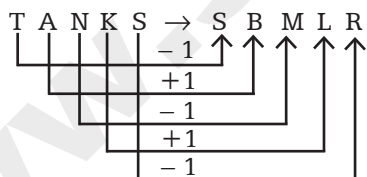

9. In a certain code language, 'SWIFT' is written as 'RIGZQ' and 'HONDA' is written as 'YGLRF'. How is 'MATIZ' written in that particular code language?

- A) KDR LX B) XRLDK
 C) XLRDK D) YPRCG
 E) None of these

Explanation :

Ans : C

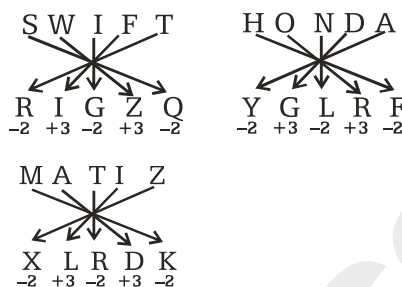

10. In a certain code, BROTHER is written as '# % \$ δ Δ @ %', and 'SEDATE' is written as '7 @ 4 2 δ @'. How is 'DEAR' written in that code?

- A) 4 @ δ % B) 4 2 @ %
 C) 4 @ 2 # D) 4 @ 2 %
 E) None of these

Explanation :

Ans : D

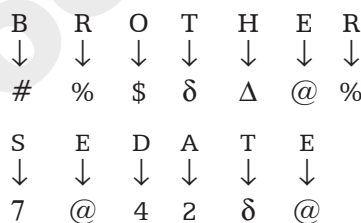

Therefore,

D E A R
 ↓ ↓ ↓ ↓
 4 @ 2 %

11. In a certain code, INDIA is written as KLBKC and FISCAL is written as DKQACJ. How is TOPIC written in that code?

- A) VMRGE B) RQNKA
 C) VQNGA D) RMNGE
 E) None of these

Explanation :

Ans : B

The pattern followed: vowels increase +2, consonant (-2).

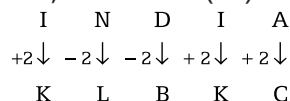

Sura's ♦ Reasoning Ability

F I S C A L
 -2↓ +2↓ -2↓ -2↓ +2↓ -2↓
 D K Q A C J
 T O P I C
 -2↓ +2↓ -2↓ +2↓ -2↓
 R Q N K A

12. In a certain code MOUNTS is written as VPNRSM. How is PERUSE written in that code?

- A) SFQDRT B) SFQTRD
 C) SFQFTV D) QDODRT
 E) None of these

Explanation : Ans : A

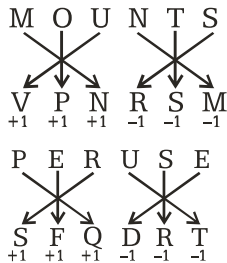

Similarly,

13. In a certain code 'ke pa lo ti' means 'lamp is burning bright' and 'lo si ti ba ke' means 'bright light is from lamp'. Which of the following is the code for 'burning' in that language?

- A) si B) pa
 C) ti D) ke
 E) None of these

Explanation : Ans : B

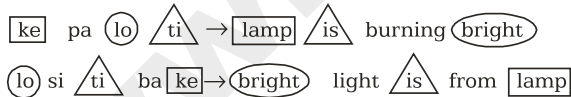

ke → lamp is → ti
 lo → bright pa → burning
 Thus, the code for 'burning' is 'pa'.

14. In a certain code RUST is written as QVRU. How is LINE written in that code?

- A) KJMF B) KJLI
 C) KMJF D) KJME
 E) None of these

Explanation : Ans : A

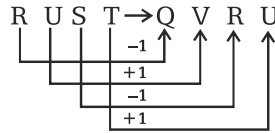

Similarly,

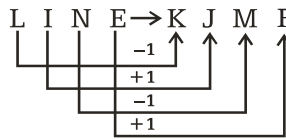

15. In a certain code language, BROUGHT is written as PSCTVJI. How is HEARING written in that code?

- A) BFIQHOJ B) IFBQIPK
 C) BFIQIPK D) BFIQHPJ
 E) None of these

Explanation : Ans : C

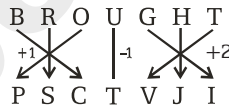

16. In a certain code JOURNEY is written as TNISZFO. How is BONDING written in that code?

- A) ANMEHOJ B) MNAEHOJ
 C) MNAEJOH D) OPCEFMH
 E) None of these

Explanation : Ans : B

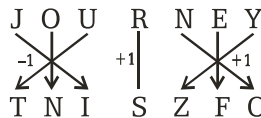

Similarly,

